

Contents

Introduction	1
1 Installation guide	4
1.1 How to choose batteries	4
1.2 How to Install Batteries	4
1.3 How to mount shoulder Strap	6
1.4 How to carry and hold	6
2 Quick guide	8
2.1 Power switch and keyboard	8
2.2 Measuring ports	9
2.3 Auxiliary ports	10
2.4 Function description	11
2.5 Adjust operating state	13
2.6 Local oscillation mode	13
2.7 Set the basic testing parameter	14
2.8 Filed strength mode setting	15
2.9 Insertion loss mode	15
2.10 Data storage	16
3 User calibration and preparations	17
3.1 Overview	17
3.2 Calibration modes	17
3.3 Calibration before S21 measurement	18
3.4 Calibration before S11 measurement	19
3.5 Reflection standard	20
3.6 Cable Compensation	20
3.7 Using the external bridge	21
4 Common measurement methods	23
4.1 Quick adjustment of duplexer	23
4.2 Antenna measurement	26
4.3 Measuring electric length of cable	29
4.4 Spectrum	30
4.5 Detecting interference source	31
5 Maintenance	33
5.1 How to clean screen, keyboard and ports	33
5.2 Other matters needing attention	33
6 Technical notes	35
6.1 Measuring principle	35
6.2 Charging time and time of endurance	36
6.3 Technical parameters	37
6.4 Inside ports	37

Introduction

KC901Q is a multipurpose RF instrument integrating a Network Analyzer, spectrum analyzer, field strength meter, and a signal generator. It can measurement the level and phase change of signals through the device under test.

Main Features

- Up to 20GHz frequency range
- 1Hz frequency step
- Good accuracy and stability
- Dual conversion, Good anti-interference ability
- Abundant functions and easy to carry

Main Functions

- Transmission measurement (Measurement phase and level difference)
- Reflection measurement (External coupler required)
- RF source and extra audio signal source
- Spectrum display and field strength observation (potentially used for inspecting a radio station's emission performance, or for searching for the interference sources)

Recommended Applications

The KC901Q is mainly used for adjusting various RF circuits, such as filters, amplifiers, splitters, combiners; With suitable external coupler it can testing input/output impedance, evaluating antenna feeding system and detecting equipment's signal amplitudes. It can also do field strength measurement, which is useful for checking the correct operation of low powered devices with integrated antennas and when searching for interference sources etc.

Combining intelligence in the community, KC901Q is a well-performing tool to study RF for hobbyists. In professional situations, it is used in communication engineering, antenna manufacturing, daily maintenance of radar, RF circuits development, Radio astronomy and satellite station. The KC901Q is light, portable, flexible and easy to use improving work efficiency, and quality.

Acceptance and check

confirm if the package is no damaged before opening it, and then when you open the package, read the introduction of the user manual carefully and make sure there are no items missing.

The standard packing includes:

KC901Q	1
Charger	1
Shoulder Strap	1
User manual	1

Please check all the items in the list provided above and make sure that there is no physical damage to the instrument, check that all the screws are in place and secure and also check that there is no abnormal sound while shaking it.

After that, connect the charger to the instrument and turn on the instrument to check that it works within specification. If batteries are in place, press and hold the power button (POWER, PWR) for 5 seconds to do the start-up check.

Safety Information

KC901Q is NOT a device for general consumers, thus the user should have related professional knowledge in order to benefit from it.

In this user manual,

NOTICE

indicates that it may cause inaccurate testing results or may incur some risk.

Warning

indicates that it may cause harms to the human body, the surroundings, or damages to the instrument, etcetera.

Please DO NOT use the instrument if it accidentally gets spilled by water or other liquid, or makes any weird sound while shaking, or when any other obvious abnormal situation occurs.

Do NOT perform any test with the instrument outdoors during thunderstorm.

Pay attention to the ground connection of the devices under test to avoid electric shock. Before the connection, equipotential touching must be done by touching the connectors first to prevent the damages to the instrument or the equipment due to potential difference engendered between systems.

Keep your eyes on the instrument while charging it. The instrument must be kept from the inflammables and explosives while is being charged or operated. Do NOT cover the instrument or the charger in case it overheats.

Be careful of the storage temperature range. Do NOT leave it in the car exposed to the sun.

Using it in any inappropriate ways is absolutely banned. People embedded with intrusive electronic equipment should use it with caution. Also think carefully before use it in hospitals, airports and other sensitive areas.

The maximum battery capacity of KC901Q is 60Wh. Choose qualified batteries for the instrument. Keep the instrument properly according to the installed batteries characters and be careful of the potential risks of the lithium battery.

Keep it from children. When KC901Q is lent to someone, urge the borrower to read the user manual first and inform him/her the safety information before using it.

Important Statement

KC901Q aligns with the third-party's technical standards and attains recognition and certification in industrial design capabilities, while it is NOT a commercialized product, therefore, it may not satisfy the aesthetical requirements on appearance of all users. But we always try our best to live up to users' expectation with our products, even still, there remains room for improvement. We embrace suggestions and feedback from all users, so your supports and understanding will be appreciated very much.

Within the law, KECHUANG and MEASALL will NOT take any responsibility of the loss which beyond KC901Q's own price in any situations. Meanwhile, we also will NOT take the responsibility of any direct/indirect loss regarding to time, business, inconvenience, profit and abuse maintenance etc. The compensations accepted will be limited to product repair, product return or exchange, and repayment in full price . We only take responsibility for the product within stipulated guarantee period.

Under no circumstances, do we make any guarantee of the KC901Q's applicability, reliability and security for uses such as medical care, military and so on. We do NOT support promises from other dealers.

***Read the technical instruction.**

**** You are welcome to support our communities: bbs.Kechuang.org.**

***** Informal functions**

For remote controlling, check our programming manual.

For upgrading, check our software upgrade instruction

Please check if there is a revised version of this user manual, as we don't release any special notifications when revisions are made. You are welcome to check and download the latest version from www.measall.com.

KeChuang Instrument Association is a scientific research community which is hosted by KeChuang Institute. It's a department that developed KC901Q.

KeChuang Institute has given authority to Sichuan Kexinshe Ltd. Co. to take charge of the production of KC901Q. At the same time, it's responsible for the Domestic distribution of KC901Q.

KeChuang Institute has given authority to Guangdong Deepace Science and Technology Ltd. to take charge of the international distribution of KC901Q.

Except the extra declarations, KeChuang Institute has all copyright of KC901Q's software and hardware.

The product of the tool chain, the components and its attached firmware, which are supplied by the thirdpart, are authorized being used by Kexinshe.

The copyright of the operation system is owned by KeChaung Institute.

The “中” logo of KeChuang and the KCSA logo, which are stylized, are the registered trademarks of KeChuang Institute. KeXinShe is authorized the use of them. “Kexinshe” is the registered trademark of KeXinShe Ltd.

Chapter One : Installation Guide

There is no battery pre-installed in KC901Q except specifically asked. The batteries will be installed by either the dealers or users themselves. Supply power with the power adapter and verify it by starting up the instrument. After making sure the instrument works properly, Turn off the power and unplug the power adapter, then you may install the batteries.

1.1 How to Choose Batteries

Lithium batteries can be used on KC901Q. For a single cell, its charging cut-off voltage is 4.2V, and the discharging cut-off voltage is 2.6V, with voltage rating of 3.6-3.7V. Batteries are connected with two in parallels then the two groups in series. The power management circuits provide the functions of overcharge protection, over-discharge protection, balance protection and short-circuit protection.

The battery compartment is suitable to the cylindrical 18650 lithium batteries, with the diameter of 18mm and the length of 65mm. The batteries must be qualified with the related standards of the formal factories.

The KC901Q can work with two or four batteries, ideally a set of four-batteries to allow longer operation. The rated charging current of KC901Q is 1A. If there are only two batteries, for single battery, the peak charging current is 1.2A. Peak discharging current is 1.5A; if there are 4 batteries, charge/discharge load should be considered and accordingly the peak currents are slightly higher than the ones mentioned above.

The batteries must be of the same type and should be from the same batch. Please do NOT mix new and used batteries and if only using two batteries, do NOT install them in ONE compartment. (See step 4 under Chart 1-2 below) Before installing the batteries, please make sure that every battery has the same basic voltage and the differences in the voltages between them is no larger than 50mV, otherwise they need equalizing by charge/discharge before being used.

Please take good care of the batteries based on the manual. Usually the low-temperature resisting batteries can be used only in winter. When the temperature is over 45°C, since the KC901Q's circuits will generate heat, the batteries set's temperature will probably exceed 65°C. In this case, high temperature rated batteries must be used.

1.2 How to Install Batteries

Required tools: one 2mm hexagon screwdriver.

Step 1: Place the instrument flatwise on the desk and take out the two screws from the bottom. (Chart 1-1)

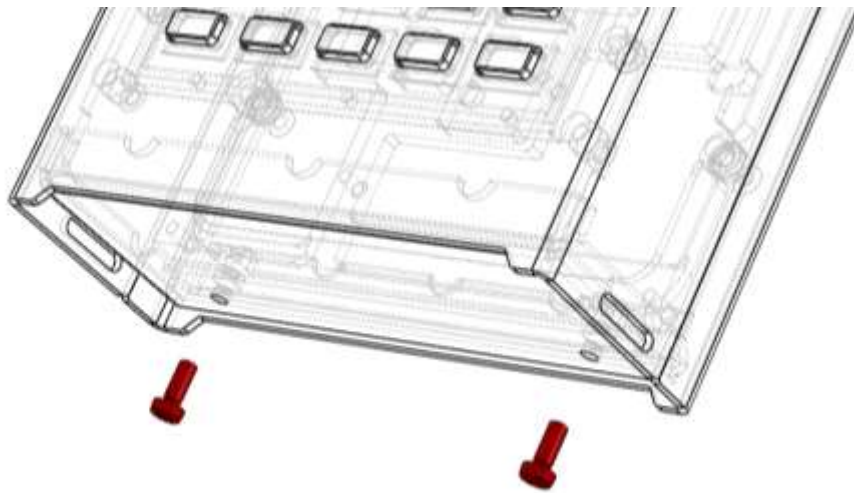

Chart 1-1

Step 2: pull the keyboard side of the shell and slide it 2cm out from the bottom (Chart 1-2). To do it, your fingers must hold the two sides of the shell hard and pull the RF adapter out at the same time. If it gets stuck, you can knock the bottom on the lower shell lightly. DO NOT knock it too hard; the maximum sliding distance is 4cm, if taken beyond this distance,, the inner cables will break.



Chart 1-2

Step 3: lift the upper shell slightly, and then turn it around to the left side.

Step 4: Install the batteries so that the positive poles are pointing toward the RF adapter. If there are only two batteries being installed, please install them separately to the most left side and the most right side. (Chart 1-3)

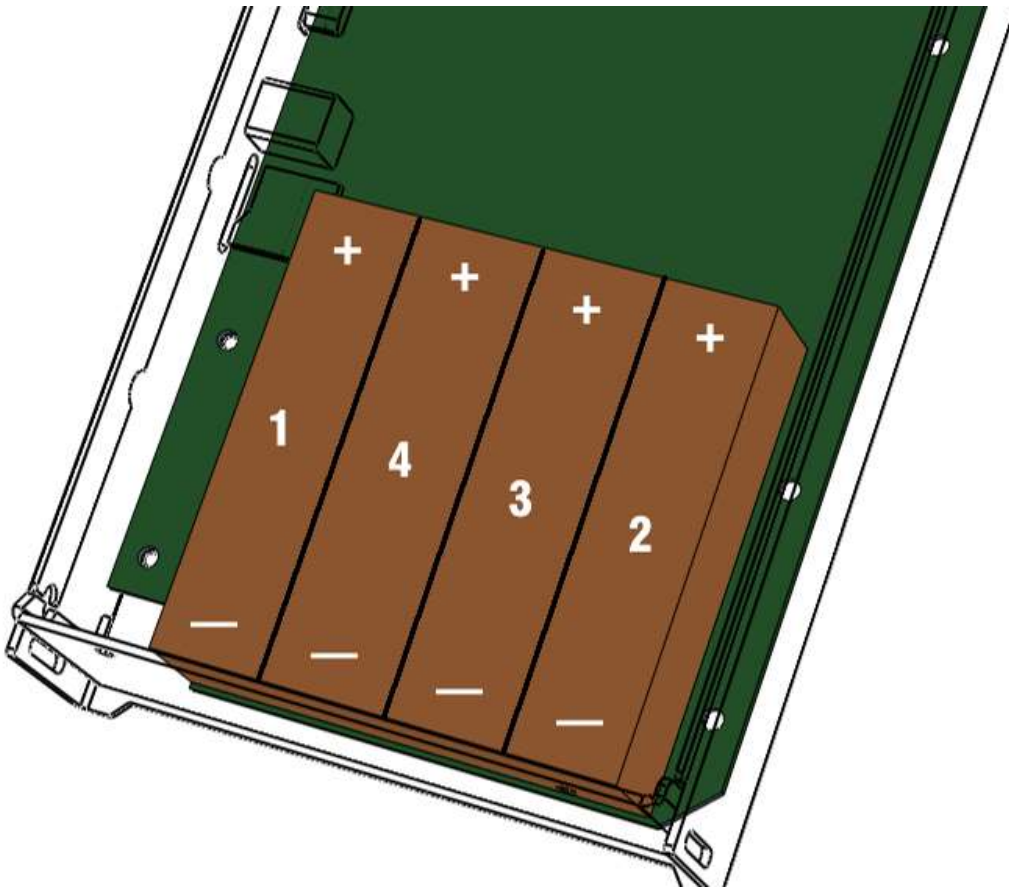

Chart 1-3 Batteries' direction and installation steps

Step 5: Check the data cable adapter. If there is any deviation and they are not correctly seated, please set them right again.

Step 6: Put the shells back together again using the reverse of the steps above. Then press the POWER button to turn on the power and then perform a functional check. If it appears to be functioning correctly, reinstall the screws.

1.3 How to Mount Shoulder Strap

There are both mounting installing holes on the instrument's upper part and bottom part (behind RF port). So you can carry the instrument either with the RF port upward or downward. If you need to carry it around, the strap mounting on the bottom is recommended.

Unfold the strap and take it out of the plastic fasteners. Then thread it through back to the mounting points and lock it back tightly in the plastic fasteners.

Warning

The standard strap is only for the carrying the KC901 during normal use. When working at height, please take extra measures to avoid the instrument falling and causing an accident.

1.4 How to Carry and Hold

After the strap is adjusted to a suitable length, the user can carry the instrument with the strap laying over his/her shoulder (such that the instrument will be at the side next to user's waist) or it can just worn with the strap around the back of the neck (then the instrument will be in front of the body). If it needs to be carried around, hanging it upside down is suggested so that it is in the ready for use when picked up without the straps in the way. Please shorten the strap before you try to carry it while running. Be careful that the instrument does not hit your body when carrying it with the strap laying over on the shoulder.

KC901Q is designed to be held with the left hand and be operated with the right hand. So when you are using while standing, the instrument should be held on its left-upper part with left hand so that the thumb is in charge of operating the knob. Also the instrument's bottom should be held against the belly. The right hand is in charge of connecting the cables and operating the keyboard.

Using the knob is optional. The user can do all the operations necessary by operating the keyboard. Button “+” , ” -” instead of using the rotating knob. The button ENTER can be used as an alternative to pressing the knob. When operating the instrument using only the keyboard, hold the unit with both hands under display screen.

KC901Q can be fixed on to a working surface by using screws through its strap holes.

Chapter Two Quick Guide

With the help of the community, the KC901Q's designers have been continuously striving to make it easy and straight forward to operate the instrument. User who has only a basic related knowledge can also be familiar with using the KC901Q within two days. Therefore, this user manual is simplified and will not detail the settings of every function. It only contains some instructions and explanations for some special parts.

The KC901Q is significantly different in function from other KC901 series instruments. KC901Q has NO Built-in coupler, can NOT measurement S11 parameter directly, The built-in output attenuator is ONLY work below 7GHz, More than 7GHz it will bypass the attenuator. Special attention should be paid when measuring amplifiers

2.1 Power switch and Keyboard

Chart 2-1 shows the layout of keyboard. Press the power button (POWER, PWR), which is on the bottom left, and hold it for 0.5 seconds. After starting up the instrument, instrument it displays the same information as the last time it was operated. The menu displays related settings in its current mode.

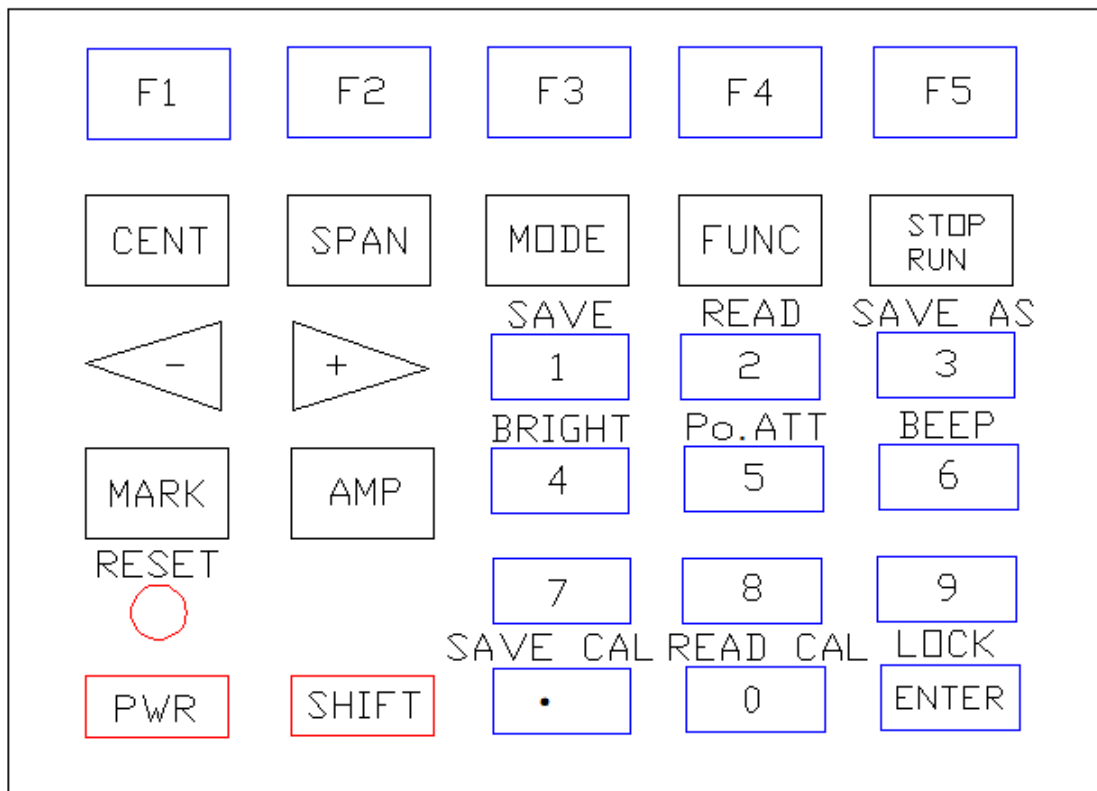

Chart 2-1: The keyboard's Layout

Chart of Keyboard's primary functions

Name	Functions
CENT	Setting sweeping central frequency
SPAN	Setting the span width (frequency span)
MODE	Entering function selection. Pressing repeatedly switches between function selection menu and function menu.
FUNC	Entering system setup and exiting system setup
STOP/RUN	Stops sweeping, starts sweeping (Toggles between each mode)
+、 -	Same as function as rotating knob, but the step is larger than the knob.
MARK	Enters into the cursor function menu (and activates knob for marker control)
AMP	Amplitude menu allows adjusting of the reference level, trajectory position, the range of the signal source function as well as the vertical extent in VSWR test.
POWER	Power switch
SHIFT	Allows selection of the secondary functions

Chart 2-1

CENT and SPAN button function can be set in “Frequency control” which is in the FUNC menu.

Chart of Keyboard’s secondary functions

Key Combination	Functions to use
SHIFT+CENT	Setting the beginning(start) frequency
SHIFT+SPAN	Setting the ending(stop) frequency
SHIFT+LOCAL	Disconnecting to the computer and forcibly switching to the local operation
SHIFT+FUNC	Resetting to defaults
SHIFT+STOP/RUN	Switching to the single step sweeping. In this mode, press STOP/RUN once, sweep once.
SHIFT+1	Saving the data to the storage card
SHIFT+2	Read the curves and settings from the storage card
SHIFT+3	Self-defining the file names after saving the data into the storage card
SHIFT+4	Adjusting the screen luminance
SHIFT+5	Adjusting the RF output range
SHIFT+6	On/off the key tone
SHIFT+.	Saving the current user calibration data
SHIFT+0	Reading the user calibration data
SHIFT+ENTER	Locking the keyboard and knob to prevent accidental operation

Chart 2-2

2.2 Measuring Ports

There are three signal ports in KC901Q. Two external RF ports (50 ohms), one AF port (1Kohm).

The N type measuring port has a precise surface which needs to be protected, Use only quality connectors and always check before connecting. If the core needle is sticking out too long or bent, fix it before making the connection. However, it's not necessary to connect an adaptor just for protecting the ports. Extra adaptors will worsen the accuracy.

The designed lifetime of RF ports is 500 times plug in/pull out. Ports' aging has certain influence on the accuracy of the vector measurement. Please replace the port connector when the old one is out of its useful lifetime.

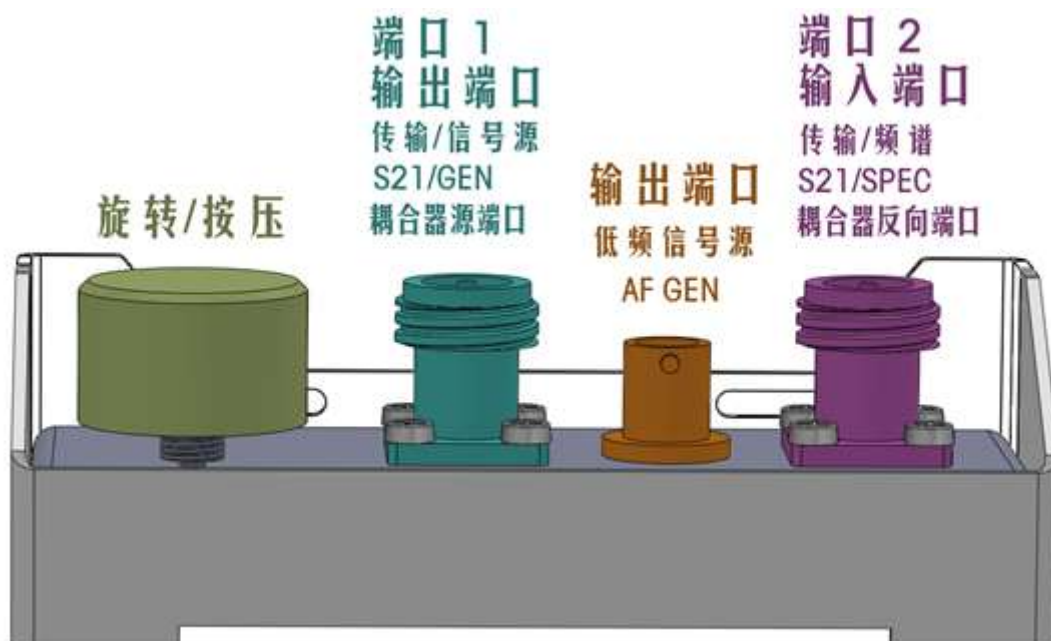

Chart 2-4 Signal ports on top

2.3 Auxiliary Ports

There are four ports at the right side as the following picture shows. From left to right: TF card slot, RJ45 Ethernet port, power input jack, and USB port. (Shown as Chart 2-5)



2.4 Function description

Six basic functions of KC901Q

- Reflection test (S11)
- Transmission test (S21)
- Spectrum (SPEC)
- Field strength (FIELD)
- RF signal source (RF SOURCE)
- Audio signal source (AF SOURCE)

MODE button is for function selection. Function can be switched by pressing **MODE** repeatedly. In most situations, user can switch back to the function menu/function selection menu by just pressing **MODE**, it can be used like a **HOME** button

Reflection test (S11)

The typical application of reflection test (S11) is to test antenna's VSWR and impedance. **For this function, please connect an external coupler, connect the coupler's input port to KC901Q's S21/GEN port, coupler's couple (reflect) port connect to KC901Q's S21/SPEC port, Device under test connect to the coupler's measurement port. Before measuring the S11 parameter, it need to do User Calibration. If measurement with same coupler it can use System Calibration to fit full frequency range.**

Reflection is measured in vector. It has various ways to display which can be chosen through the **FORMAT** menu. When showing Smith chart and the impedance, the soft menu from the second left can provide more options for display.

Access: Press **MODE** and then choose the item of reflection test (**S11**) in the menu.

Transmission test (S21)

The typical application of transmission measurement (S21) is measurement amplitude-frequency or phase-frequency characteristic chart for filters and amplifier. For this, both two N type RF ports need to be used. Signals are output from the instrument's left side port (S21/GEN) and input into the right side port (S21/SPEC).

Access: **MODE** and then choose item **S21**.

Insertion Loss Measurement is a transmission measurement at single frequency point that can respond so quickly enough that it allows users to adjust the Device Under Test (DUT) more efficiently. It can also be used for accurate filter adjustment as well as measuring the antenna gain.

In order to align with the operation of other types of devices, turn-on/off setting of insertion loss measurement function has been placed in the field strength mode menu.

Access: press **MODE**, choose **FIELD** in the menu, then choose Insertion. You will see that “**GEN ON**” on the right down of the screen. See further information on field strength functions information after the spectrum function below.

Spectrum (SPEC)

Spectrum mode (SPEC) is typically used for monitoring frequency occupation and interference, can be used for testing RF circuits. But when a 109.65MHz signal is present that need a pre-selector filter. When connecting to the KC-R100B directional antenna, SPEC can even detect hidden emission sources. (Spectrum function uses the S21/SPEC port)

Access: Press **MODE** and then choose **SPEC** in the menu.

Field strength (FIELD)

Field Strength mode (FIELD) is for testing field strength and signal coverage and also detecting the amplitude of RF signals in circuits. Due to DC isolation being already installed, users can connect probes to test signals without affecting the DC bias in receivers and transmitters directly. However please be careful of impedance's match so that the measurement does not affect the normal operation of the equipment under test. Also it is necessary to take safety measures such as adding extra attenuation to protect the attenuator and the DC block which are concatenated with KC901Q. when measuring transmitters. Proficient users can use field strength mode to quickly judge if radio station's emission is strong enough. For this mode, please use the port on the right side.

Access: Press **MODE** then choose FIELD in the menu.

RF signal source (RF SOURCE)

RF Signal Source (RF SOURCE) is for producing a signal in mW range, its typical application is to transmit a weak signal to check radio receivers sensitivity on a frequency from a short distance away. A skillful operator would also find these low level radiated signals of great value. An external attenuator can be added to extend the uses of signal source when the RF generator port is directly connected to other equipment.

Below 7GHz, The RF signal source's output level can be setting through internal output attenuator. Instrument's output attenuator can also be used as an amplitude modulator generating ASK signal. If the output attenuator is already used for setting output power, the modulation depth is limited by output attenuation level. The bigger the attenuation is, the smaller the modulation level which can be used will be.

In RF signal source mode, please use the N-port on the left side.

Access: Press **MODE** and then **NEXT**, finally choose **RF SOURCE** in the menu.

Audio signal source (AF SOURCE)

Audio Signal Source(AF SOURCE) is for producing a low-frequency voltage signal. its typical application is to adjust the audio signal paths in devices. Since the audio signal source can produce a steady output up to 50MHz with various modulation, it can also be used for adjusting RF circuits under 50MHz.

The Audio signal source actually can be set to a very high frequency (performance can't be guaranteed). Assisted by the under-sampling output, it can also be used for adjusting radio station's sensitivity and so on. The AF generator has the option of its output being selected as the central BNC AF gen output (1Kohm), Port2 or Port1 (both 50 ohms).

Access: Press **MODE** and then choose **NEXT**, finally choose **AF SOURCE** in the menu.

2.5 Adjust Operation State

On power-on, under the default setting the device will automatically sweep once, and then turn STOP. Thereinafter, you must restart it by pressing **RUN/STOP**, then it keeps sweeping until you push the same to stop. By clicking **SHIFT** first and then press **RUN/STOP**, a secondary function of the RUN/STOP button is activated (shown in the screen the sign ""); and this is for one-time sweep. In this mode, each time you press RUN/STOP the device will run once only. Re-press SHIFT + RUN/STOP to terminate this mode.

 Single sweeping mode. Instrument sweeps only once with each RUN/STOP press.

 continuous sweeping mode. Instrument will do the constant sweeping. In the single sweep mode, this sign will also be shown while sweeping.

 Stop sweeping. RF circuit's power will be cut entirely.

If the main setting parameters are changed when not sweeping, instrument will scan once automatically.

NOTice:

Since there is no warm-up, the result will be less precise in the single sweeping mode and thus it is more suitable for qualitative analysis. To collect more accurate data, instrument must be set to "continuous sweeping mode".

2.6 Local Oscillation Mode

There is a **Local oscillation mode** in each of the following modes: SPEC, S21 and FIELD. This function is for judging signal imaging.

LowLo: Low local oscillation. The LO frequency is lower than the test frequency. The image interference is from the low frequency side.

HighLo: High local oscillation. The LO frequency is higher than the test frequency. The image interference is from the high frequency side.

If there is a signal showing in the same position on the screen whether in LowLo mode or HighLo mode, this signal is probably a truly existed signal. On the contrary, if a signal disappears in whichever mode, it is probably fake. If it shows in LowLo mode but disappears in HighLo mode, the real frequency probably is 219.3MHz less than the one that is shown. If it shows in HighLo mode but disappears in LowLo mode, the real frequency probably is 219.3MHz more than the one that is shown.

When the frequency is lower than 200MHz, the local oscillation setting is invalid. In this case, image interference can be filtered through low-pass filter.

NOTice

The factory calibrations of spectrum, transmission and field strength modes are done in HighLo mode. The test may be inaccurate under LowLo mode.

2.7 Basic Testing Parameters Setting

To set the **central frequency**, press **CENT** first, then enter the frequency on the number pad. If the desired frequency is near the current frequency setting, user might use the wheel knob or press “+” “-”.

To set the **sweeping width**, press **SPAN**.

To set the start frequency (START), use the combined key **SHIFT+CENT**.

To set the stop frequency (STOP), use the combined key **SHIFT+SPAN**.

If you are used to enter the frequency with start/stop frequency, you can set the frequency control item as “**START/STOP**” in **FUNC** menu.

To adjust the reference level, press **AMP** or rotate the wheel knob clockwise or counterclockwise, or simply use the “+” and “-” buttons.

While testing VSWR, button **AMP** is for adjusting the amplitude display division. Pressing it repeatedly can switch the range among large, middle and small.

Sweeping point's setting is in the **FUNC** menu, shown as **SWEEP POINT**. It is 450 points in most situation and it's not necessary to change it in usual cases. Instrument will choose the suitable frequency step (STEP) automatically according to the sweeping width.

Sweeping speed can be set in **FUNC** menu with 3 levels: fast, middle and slow. Usually the middle level is adopted. The fast level can increase efficiency by shortening the sweep time, while reducing accuracy rate; if this is the case, there will be a “*” shown on top right corner of the screen to notify user that the result is not accurate. The RBW of S11 and S21 need to be set in the **FUNC** menu. The smaller RBW is, the slower the instrument sweeps. Normally factory calibration is executed on 10KHz RBW, so it is recommended to set RBW as 10KHz unless specially required in other situations.

In the menu of S21, item (dB/div) can be used for switching the range of ordinate.

2.8 Field Strength Mode Settings

Field strength mode is measuring the level of input port signal. Field strength's value derives from the calculation of input level and the antenna's coefficient. Antenna's coefficient is mainly related to antenna's gain and frequency. So make sure that the instrument gets the antenna's gain in order to obtain the accurate field strength.

After enter field strength mode (FIELD), there is an item (**ANT GAIN**) in the menu. Press the button and choose the sign with "+/-" in the menu, next enter the antenna's gain on the number keyboard.

The update speed of the number display can be set in 3 levels: FAST, MEDIUM and SLOW. MEDIUM is recommended. The update speed of the scale-meter will not be influenced by this setting, but for observing the transient strength change of signal strength.

Warning

KC901Q is a network analyzer, so there is no protection for local oscillation's leak. If used for observing the spectrum or field strength, there must be local oscillation signal flow into the receiving antenna and its strength degree can reach -10dBm. Its frequency is at 109.65MHz plus or minus the receiving frequency. User should estimate the consequences and if needed, use Po. ATT function of internal attenuator or avoid the interfering frequency points by setting local oscillation as well as adding a band-pass filter.

2.9 Insertion Loss Mode

Insertion loss test is actually a single point S21 measurement.

Firstly, enter field strength mode, and then choose "**Insertion**" on the bottom right corner on the screen; then there will occur a "GEN ON" sign. The data on the left side of the screen is the absolute level value, while the data on the right is the relative level. To calibrate, connect the testing cable directly to each RF port, and then choose **AUTO CAL** in the menu. After calibrating, connect the device under the test to the testing cable. Reading at the right is insertion loss.

2.10 Data Saving

To save the data, insert a micro SD (TF) card into the instrument.

In test function, press combined key SHIFT+1 to save the current screenshot, and the test results and settings as a chart.

The file will be automatically named by system. If you want rename file use the combined key SHIFT+3.

While connecting the instrument to PC via USB, the instrument is detected as a USB flash drive. In this case, the SD card is already taken over by the PC, therefore when connecting to PC, data can't be saved.

In S11, if you need to save the files of S1P format or all original testing points, you need to save it in the Smith chart mode.

2.11 More Information about the System Settings

Normally the **FUNC** button pops you into the operating surface, where you can further access the Advanced System Setting Surface (ASSS) with the combined key **SHIFT +7** . In the ASSS the parameters must be examined to be correct to achieve measurement validity. You can reset all parameters to the defaults via the Factory Reset function. But be

Sweep point 450 is recommended to boost up the sweep speed

(1) The sweep speed shall better be MEDIUM, since HIGH level is only applicable for qualitative analysis because of the louder noises and data deviation under this mode; and LOW level is ideal for enhancing accuracy though, it requires minor calibration manually.

(2) Select "INT" for both FREQ REF and TRIGGER

(3) Select "INT" for S11 BRIDGE for a built-in bridge

Chapter 3 User Calibration and Preparation before Measurement

3.1 Overview

Since the KC901Q does not have a built-in coupler, there is no factory calibration data for the S11 function and must be calibrated after installing an external coupler. For the S21 function, it has been calibrated on its own port at the factory, but due to the distance between the two ports, the phase of the factory calibration has no meaning. When only the trend observation of the S21 amplitude-frequency characteristic is performed, it is not necessary to calibrate in order to simplify the operation. If a phase measurement is involved, calibration must be performed.

In terms of measurement, cables and adapters are commonly used but these accessories will induce loss and phase shift. Furthermore, its performance is subject to changes such as temperature and time, accompanied with drift. Under the circumstances which interferences could seriously impact the results of the measure, the instrument would need an immediate calibration.

Calibration data is only valid if measuring DUT under the same conditions (cables, adaptors, temperature, analyzing bandwidth and sweeping speed etc.) as performing the calibration; or else new errors will occur when any condition changes. In a word, calibration conditions should be as close as it can be the actual situation of the test.

Try to reduce the frequency of changing different adaptors during testing, particularly it's not recommended to put on an extra adaptor for whatever reason.

3.2 Calibration Modes

There are three kinds of calibrations in KC901Q, factory calibration, system calibration and user calibration.

Factory calibration: Instrument has a high-density full-band calibration, using scaling algorithm to conduct more precise interpolation. The factory calibration is saved into the instrument permanently; users cannot reset it or use it directly. But it can override the system calibration by restoring factory settings.

System calibration: after the instrument comes out from the factory, the data of system calibration is the same as factory calibration. System calibration can be used directly and recalibrated by the users. It avoids further calibration since the System Calibration in that in whichever frequency the device will execute sbasic error correction. If it runs the "factory reset", the system calibration which is set by user will be abandoned and the system calibration data will be the same as the factory calibration.

User calibration: it can be set by user anytime. This calibration will do the correction to every data point according to the actual setting. There will not be interpolation errors. Therefore, its accuracy is higher than the factory calibration and the system calibration. User calibration is only effective for the set frequency. If the set-

ting parameters are changed, the calibration data will be useless though, it will be saved temporarily lest we go back to the last setting parameters; in this case the previous calibration data is still valid.

Calibration procedure

Under the S11 and S21 display modes, every menu on the very right side has “**CAL Select**”. It’s for switching among system calibration, user calibration and shut down calibration.

To start out the user calibration, choose “**RE CAL**”.

In **FUNC** menu, access into the system calibration with the combined key **SHIFT+7** .

When entering the calibration interface, the surface will pop up specific operating methods. When carrying out the S11 calibration, users can SKIP the loading procedure (LOAD).

The electric length of calibration module’s electric **length parameters** must be preset first in FUNC menu.

3.3 Calibration before S21 Measurement

As long as within the dynamic range, series attenuators (above 6dB) are highly recommended to minimize the errors.

If the DUT is small and light, you can connect the DUT’s port to the instrument directly, although it is not a good practice. In this case, only one RF cable is needed for a complete testing system. If the DUT is too big and heavy or the adaptor does not match, then you need two RF cables.

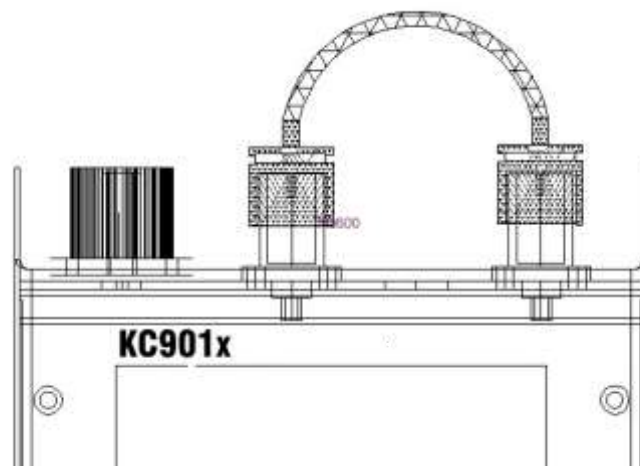

Chart 3-1A: Connect with one cable in calibration

You can use either one or two cables to execute the calibration. As for using one cable, simply joint the two ends of the cable to the two ports respectively (Chart 3-1A). As for using two, firstly use a thru-connector with a known electric length to

connect the two cables, and next joint the rest of the two ends respectively to the two ports (Chart3-1B). There you can calibrate the instrument on your own.

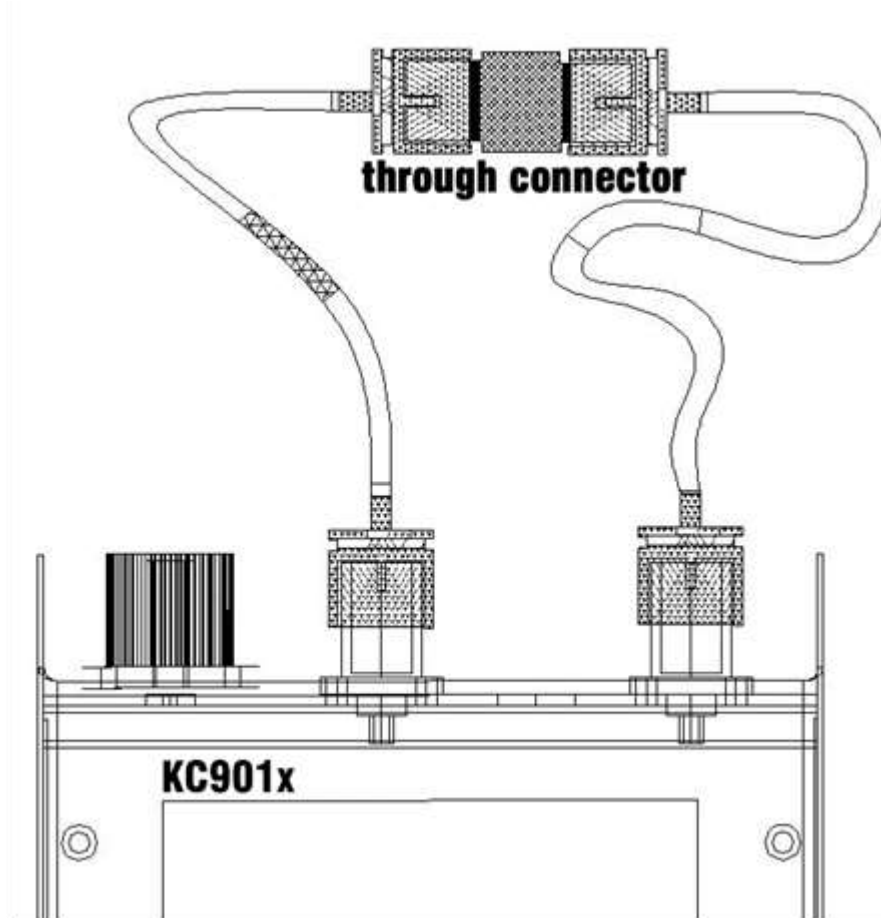

Chart 3-1B: Connect two cables in calibration

If there are many cables which are connected in series in different places in one system, user shall better connect all of them together in series then do the calibration.

When testing power amplifier, the power amplifier's output should connect in series with an attenuator to avoid excessive RF power that will damage the instrument. If the amplifier is a small -signal amplifier, connect the attenuator to its input port otherwise the drive signal being too strong; moreover before implementation, all the attenuators and cables should be connected in series to do the calibration.

To start the user calibration, choose "**Re CAL**" in the function menu and then follow the guilds.

Set the parameters of the calibration kit (or other adaptors whose electric lengths are known) in the FUNC menu. Pre-setting the calibration kit's electric length enables the instrument to compensate calibration kit's phase shift automatically. For the testing system where there are several cables and adapters, in the FUNC menu, the thru adaptor's electric length should be set as the sum of the adapters' electric lengths which will later be removed from the actual test.

To change the frequency after the calibration, the instrument will select system calibration automatically.

3.4 Calibration before S11 Measurement

Function S11 has multiple display modes yet it needs calibration once only, given that the calibration parameters can be used in all modes.

Before use S11 features an external bridge or coupler must be installed. The manufacturer is not aware of the performance of the bridge or coupler installed by the user, so factory calibration is not available and there is no system calibration. System calibration or user calibration is required after the bridge or coupler is installed.

Chart 3-2: Connect the coupler

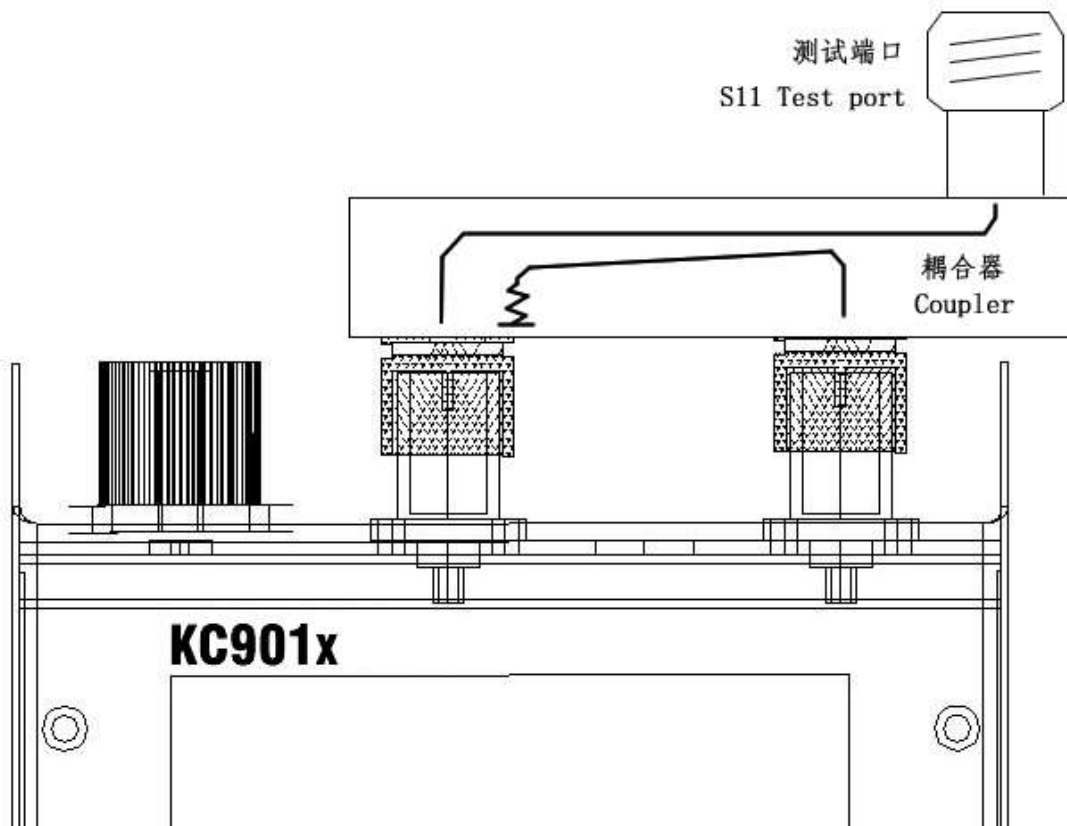

If usually using same one coupler, user can do System Calibration for this coupler. If just use the coupler in one time, user can do User Calibration only. But if frequency changed, the User Calibration will not available.

User calibration should be done in the following situations:

- Verifying important devices (e.g. antennas for broadcasting and TV station).

- DUT fails to directly connect to the instrument, where necessitates extra cables.

After calibration, test if the curve of open and load are shown normally. If there are some obvious errors, redo the calibration. In VSWR mode, curves in an open circuit should be over than 10; when connecting to the load, it should be under 1.1.

To access the System Calibration, Press FUNC to go to the function menu, then press SHIFT, Press 7 it will go to the System Calibration meun. Select the S11 System Calibration, then press ENTER, follow the operation tips to do the System Calibration.

To do User Calibration, Choose “Re CAL” in mode S11 and then follow the operation tips.

NOTice

Executing calibration at the far-end of the external cables, under the condition which the external cables’ electric lengths exceed one half of the wave length of the frequency (STEP), user needs to increase the sweeping points (or reduce SPAN) before the calibration to avert the phase aliasing. For example, STEP 3MHz converting to wave length equals 100m. The external cable must be less than 35 meter (Electric length = cable’s actual length/speed factor).

3.5 Reflection Calibrator

S11 abides by SOL calibration, in which the three capital letters respectively represent 3 types of calibrators: short, open and load.

KC951011/KC951012 is the SOL calibrator that we (Kexinshe) produced. Users can also use other proper calibrators, but keep in mind that the terminal effect of the chosen calibrators must be small enough since there is no compensation for KC901Q (non-commercial version). KC951011’s nominal electric length is 5.26mm and KC951012’s one is 0. If a user chooses other standard, he/she needs to input the value of the actual electric length in the FUNC menu and choose the CAL KIT DATA.

To attach the calibrator tightly with instrument, clamp it hard with the thumb and the index finger. If using a torque spanner, the torque should better be 135N.cm.

Calibrator are expensive accessories that should be taken good care of and better be scrutinized from time to time. Check the adaptors before calibration to prevent unexpected damages to the calibrator.

3.6 Cable Compensation (Extension)

In order to connect the instrument and DUT, usually we can calibrate on the end of the RF cables; but in some restricted occasions, users can either appeal to the system calibration or just calibrate it by manual, thanks to the compensation function that erases the influences by the cables on measurement. Of course the second method brings about lower accuracy rate than the first method does.

Firstly, strictly follow the steps shown in Section 4.3 to test the exact electrical length of the cable. If the cable’s velocity coefficient is already known, electric length can derive from calculating cable’s mechanical length. But it will be less accurate than actually measuring it.

When the cable cannot be disconnected from the antenna easily, users can again turn to Section 4.3 to test the electric length. Choose those frequency bands whose phase variation tendency is steady, meanwhile phase-frequency characteristics curve should be rather straight. In this way, usually the tested electric length will extend to antenna’s feed point, which is a more effective way to do the calibration than adjust-

ing the antenna. This method also applies to the occasion where calibration is executed on the end of the feeder in that by doing so, users can maintain the phase plane extended to feed point.

Press **FUNC** to enter system setting interface. There is an item " **Cable data**". Enter the testing result into " **Cable Length**".

" **Cable attenuation**" means antenna's single attenuation in " **Cable frequency**".

The best way to measure cable attenuation is using S21. But sometimes in reality, users may be set back from performing the calibration on the other side, in other word, fail to do the S21 measurement. There we need to enter the data from the cable's factory. Of course we can also appeal to S11 to measure it in far-end open circuit: if there are fluctuations in the curve, take the wave crest of less attenuation near the final-expected frequency band. Pay attention that the reading number should be divided by 2. When the attenuation is unsure, set it as 0.

Once "Cable data" is set, instrument will try to cancel the cable influence with it. After the measurement is done, reset the parameters in time to prevent mistakes in future use.

Cable parameter is also effective in S21 measurement.

3.7 Necessary Preparation

3.7.1 Check battery status before going outdoors, particularly when working outdoors for long hours, bring the charger as well (a external battery pack is more helpful in the absence of socket). A shortcut to test if there remains enough power, run the instrument and read the voltmeter; if the meter shows a voltage over 8.0 V, it has at least half of the power left for use.

3.7.2 Be cautious of the instrument and prevent exposure to water or rains when working outdoors. It is better be safeguarded in a waterproof Pelican case.

3.7.3 When it may be necessary to measure an amplifier or transmitter, prepare enough attenuators. When the tested signal is suspected to be over the instrument's limit, user must connect the attenuators in series.

3.7.4 When testing in places where antennas may work intensively, such as broadcast and television tower, to ensure interference will not have much effect on the result, it is advised to test the coupled power of the antenna beforehand with the terminal power meter, and the meter should indicate lower than 0.1W. Besides, when other antennas are working, it will engender powerful emissions that may couple together, which will definitely do harm to the instrument.

3.7.5 When testing antennas near the high voltage power line or a substation, please check that the coupled voltage on the port which under test with ac voltmeter. The induced peak voltage shouldn't be over 15V. Also coaxial cable's shielding layer should be grounded nearby.

3.7.6 If using a probe to measure RF signal on circuit board, it is imperative to connect the external shielding layer of the cable with circuit board's ground together, or else it probably will break KC901Q.

3.7.7 Instrument can measure passive devices while it's charging. But user should avoid using it on active devices in the same situation. If user insists on doing so, please connect the ground of KC901Q (the external layer of the coaxial connector) to the ground of the DUT in equipotential connection to prevent the damages due to the voltage difference between two.

3.7.8 If user needs to test at somewhere high, prepare enough firm safety ropes and packing bags. Also set warning zone under the tower.

Chapter Four Common Measurement Methods

4.1 Quick Adjustment of Duplexer

Duplexer is an important part of a repeater. Its insertion loss and isolation ratio are related to the performance of the repeater. In frequency band which is used commonly in UHF/VHF, KC901Q can provide an operation range better than 100dB. User can adjust the duplexer into the best state under its monitoring.

Prepared accessories: a 50Ω load, 2 RF cables, necessary RF adaptors

Fixing KC901Q on the workbench

tools: a socket spanner with a center hole, screwdrivers. If it's possible, fix the duplexer which is under the test on the workbench.

Special settings: In the beginning of the adjustment, user can use middle speed or high speed (FUNC, Speed). When doing the fine-tuning to the trap frequency point, user should adjust to **Low** Speed; or the insertion loss mode can work as well.

Take band trap theory's six-cavity duplexer as an example to introduce the adjusting steps.

Set KC901Q to S21 and then set its center and span so that the frequency range covers the original and the new frequencies of the duplexer. AMP can be set as 0dB or +10dB (AMP and ordinate range can be switched according to the curve's position.). After turning on the system calibration, move mark1 and mark2 nearby duplexer's new receiver frequency and transmitter frequency.

To begin with, measure the insertion loss of the RF cable (S21); slightly shake the cable and adaptor, and see if the curve shakes as well: if it does, double check the contact point. Cable's insertion loss should be neglectably small and be steady as well. Choose a cable of adequate quality. User can hang the cable in the air to check the position of instrument's noise floor. In 450MHz, it should be at least up to -90dB though, better below -100dB.

Clean up the socket of the duplexer, and then connect one of the instrument's RF port to duplexer's TX input port (usually noted as high). After that, connect instrument's another port to duplexer's ANT (antenna) port. Finally, connect the dummy load to the remaining RX port (usually noted as low)(Chart 4-1).

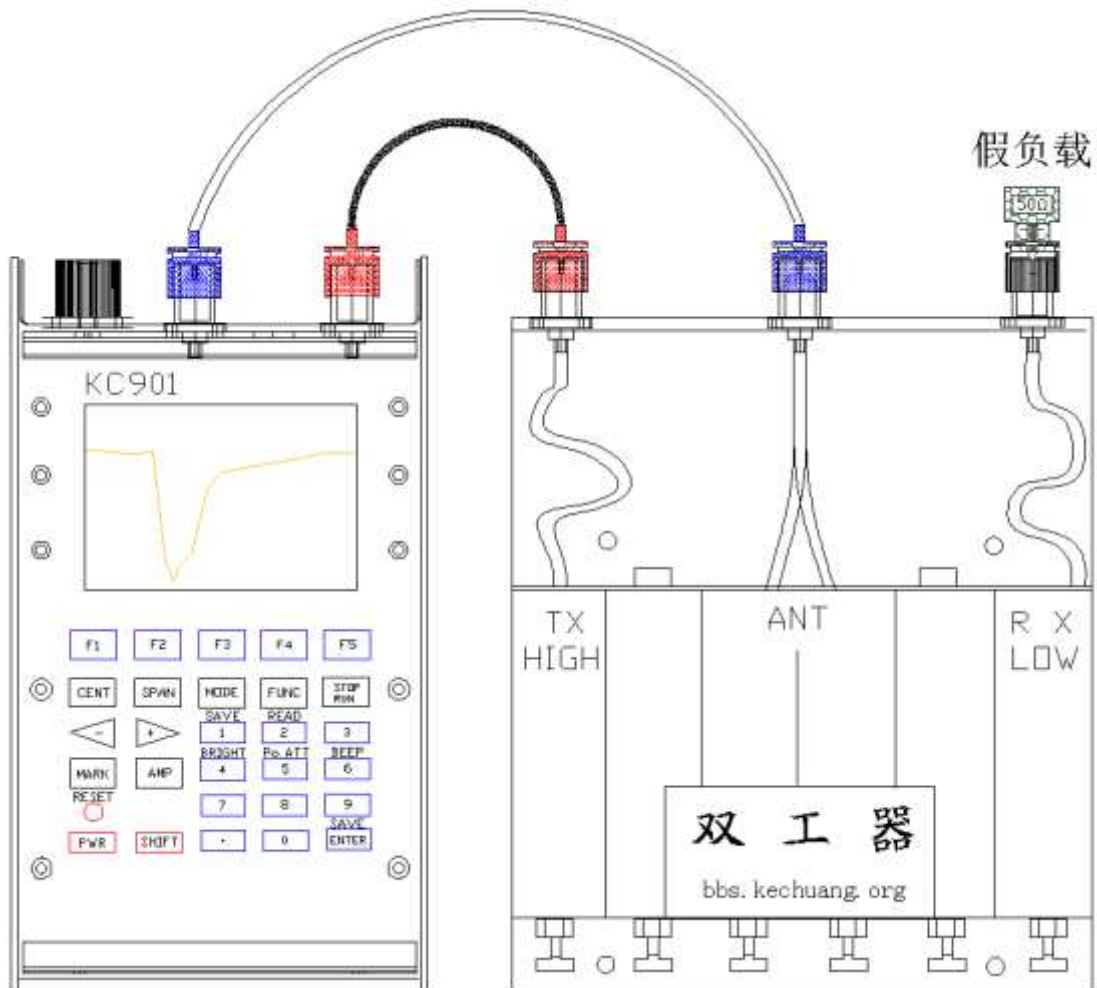

Chart 4-1: Example for connection method of duplexer measurement

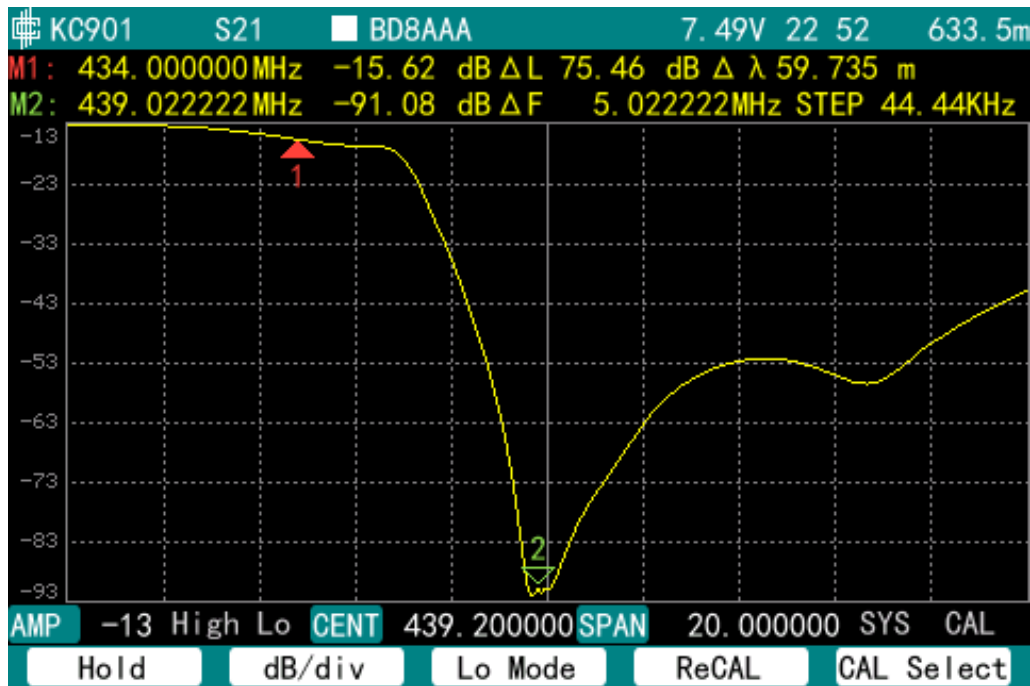

Chart 4-2: Typical curve of duplexer's LOW side, uncompensated cable loss

Adjust the three screws nearest to the TX port (the first three on the left in Chart4-1) until the dip point moves to Mark1 (M1) (Chart4-2). Fine-tune the screws step by step meanwhile monitor M1's S reading till it makes to the minimum negative number. Normally it can reach -60dB. Right now, M1 indicates the insulation of the HIGH side, and mark2 (M2) indicates the insertion loss of HIGH side.

Connect KC901Q's output port to duplexer's ANT port, and then connect the input port to the RX port and the dummy load to the TX port. Adjust the three screws nearest to the RX port (the last three on the right in Chart4-1) until the dip point moves to M2 (Chart4-2). Fine-tune these three screws from left to right one by one repeatedly, at the same time, monitor M2's S reading till it probes to the minimum negative number. Also generally, it can reach -60dB.

Adjust the central frequency and sweeping span to zoom in the new curve. Then adjust the positions of maker1 and marker 2. Finally connect the testing cables with a thru-coupling to perform user calibration.

Then connect instrument's output port to duplexer's TX port, the input port to the ANT port and the dummy load to RX port. Fine-tune the three screws from left to right repeatedly till the M1's S reaches the minimum. In normal situation it should be lower than -70dB. The derived S-parameter of M2 is the duplexer's insertion loss to the transmit signal.

To get the insertion loss of the duplexer to the receiving signal, connect the output port to ANT port, the input port to RX port and the dummy load to TX port. After that, fine-tune the three screws on the RX side to get to M2's minimum, commonly lower than -70dB. There we get the S-parameter of M1, which is the insertion loss.

Switch the LO (Local Oscillation) mode, compare the minimum value of each curve, and find out the lowest among. When adjusting both sides of the duplexer, different OSL modes may need to be used.

Some duplexers' parameters of both sides can influence each other. In this case, user may need to do the steps above again till the attenuation parameter is up to -70dB.

Do not make the notch curve of the duplexer too sharp pointed at the bottom. Through reducing the SPAN to 1MHz, observe the curve's bottom: it should be more than 100KHz wide. If the curve is too sharp, its tip may drift out of the used frequency once temperature or the matching of antennas has changed.

When there is conflict between the insertion loss and the attenuation, consider the attenuation at RX side first. Properly lower repeater's transmission power to lower the demand of isolation. In this case, keep in mind that "adjust TX toward inside, adjust RX toward outside" to try to keep the balance between insertion loss and isolation.

For coupling level, user can adjust the coupling bolt with the duplexer which is adjusted by the screws. The other adjusting screws can be replaced with the longer ones if necessary. If the screws need to get inside very deep, duplexer's Q value will reduce. If needed, user can lengthen solenoid by taking apart the duplexer.

If the insertion loss can't be reduced to a reasonable level, user might consider using S11 (connect the dummy load to the untested port and it's not preferred to connect it to instrument's port) to try different adjustments. Also balance it with other parameters and make SWR stay within 1.5.

During the adjustment, user should lock the screw to fix the parameters.

NOTice

Port matching has a great influence on duplexer's attenuation. There will be some tiny differences of the results by using different instruments. There also will be differences after changing the connections between instrument and duplexer. There are differences too for different repeaters and antennas' impedance which may cause gap between its actual performance and the expected performance. In the initial testing, after putting the repeater in, users should be accumulating operating experiences from each actual performance .

Concatenate the attenuator (about 10dB) with instrument's input port to improve the matching.

4.2 Antenna Measurement

WARNING

The maximum output generated from the output port of KC901Q is 10dBm(10mW). The output will be transmitted to the air via the antenna during testing. To diminish the transmission, users can increase the output attenuation (**Po.ATT**) below 7GHz. A recalibration (**Re CAL**) is imperative in this case.

4.2.1 SWR Measurement

When measuring SWR, set the instrument to S11 and select the Format as VSWR. Connect the antenna and coupler correctly, Using adapter if necessary. User must stay away from the antenna after setting the center and span.

Antenna's standing wave ratio is related with the field environment. So users should choose a capacious open-air, such as the roof. The cable should be as short as it can be; if the RF cable is too long, disconnect the end from the antenna, and then do the user calibration at the end of cable.

4.2.2 Cable canceling

When measuring antennas, users may not be able to calibrate on the antenna's port due to the limitation of the field environment, therefore, there exists the influences from the coax on the result. In such cases, users can "wipe out" the cable by inputting the cable's length into the instrument to get the antenna's RF parameters.

There are two items in FUNC menu, which are "Cable Length" and "Cable Loss". Cable length is the actual length of the cable divided by the velocity coefficient. With cable length, cable loss can be predicted according to the loss per unit length which is provided by cable technical manual.

Both two items above are the one -way -travel parameters.

The operation of cable canceling is only suitable on low frequency, for instance, under 30MHz. Thus as long as permitted, users are highly suggested to do the user calibration on the end of the cable so that the instrument can remove the cable's influences precisely.

4.2.3 Antenna Impedance Measurement

KC901Q can calculate antenna's impedance by testing RF signal, amplitude differences of reflection signal and the phase differences. Since amplitude and phase differences are related with the feeder line, the user calibration must be performed on the end of the feeder line unless the antenna connects to instrument directly.

Antenna's installation environment has a great impact on antenna's impedance. For the sake of a more accurate measurement, make sure the antenna system setup is as close to the application environment as possible. Antennas installed on devices such as handheld device and routers are integrated with the devices' metallic conductive casing, thus they should be tested with the case. For example, to test the antenna of the router, the router ant's host device case should be tested together, and the original coax need to be disconnected from router's PCB for the antenna. The end of the testing cable, which is near the antenna, needs to go through the toroid ring. During the calibration, make sure that this cable is included.

Under the low frequency, if it's not able to do the calibration on the cable, user can set cable length in FUNC menu to remove its influence. But it is not applicable to the occasion when the frequency is relatively high (for example, 2400MHz).

4.2.4 Simple Measurement of Antenna's Gain and Antenna Pattern

KC901Q can test antenna's horizontal pattern or the front-to-back ratio with S21 (or insertion loss) function with another set of antenna; it can even test the antenna gain adding one more set of antenna whose gain is known.

Measurement environment: RF anechoic Chamber or standard measurement site. For engineering measurement, choose somewhere open-air and flat, with the size more than 20 times of the wave length; generally the flat roof is acceptable to test antennas whose frequency bands are over UHF.

Equipment: Two antenna stands, one has a turntable on the top. Antenna stands' heights should correspond with the functional design of the antenna, normally it should be larger than two operating wavelengths. The distance between the two stands should be longer than 10 times of the operating wavelength (it is also acceptable a shorter distance when testing antennas whose operating wavelengths are exceptionally long, like short-wave antenna). Additionally, to remove the effects of ground reflection, execute multiple testing at various distances so as to obtain the average value among the results. Prepare a cable long enough to fit in the distance between the stands, also allow a distance (between the operator and the instrument) of at least 10 times of the wavelengths. Besides a tested antenna, a directional antenna may be needed. To test the antenna gain, prepare another reference antenna whose gain is already known.

Method: install the testing antenna and the antenna under test on the stand (Chart 4-3). Testing antenna's main lobe should align with the antenna under test. In specific, the first step is to align the under-the-test antenna's certain direction (a predicted main-lobe direction or just mark a direction) with the testing antenna. Secondly, set the instrument to mode S21 and enter the testing frequency. Commonly choose a smaller span, 1MHz for example. Perform the user calibration in S21 mode to make the curve return to zero. Rotate the under-the-test antenna within a certain angle and record the corresponding S-parameters (dB) of every angle. Finally, mark the points on the angle-gain coordinate graph to get the directivity diagram of the under-the-test antenna.

The measurement mentioned above can also be done in insertion loss mode. Firstly, enter into the FIELD mode and choose **Insertion** to start the insertion measurement. Then press **Auto CAL** to make the insertion reading return to zero. Its insertion reading shares the same meaning with the S-parameter in S21.

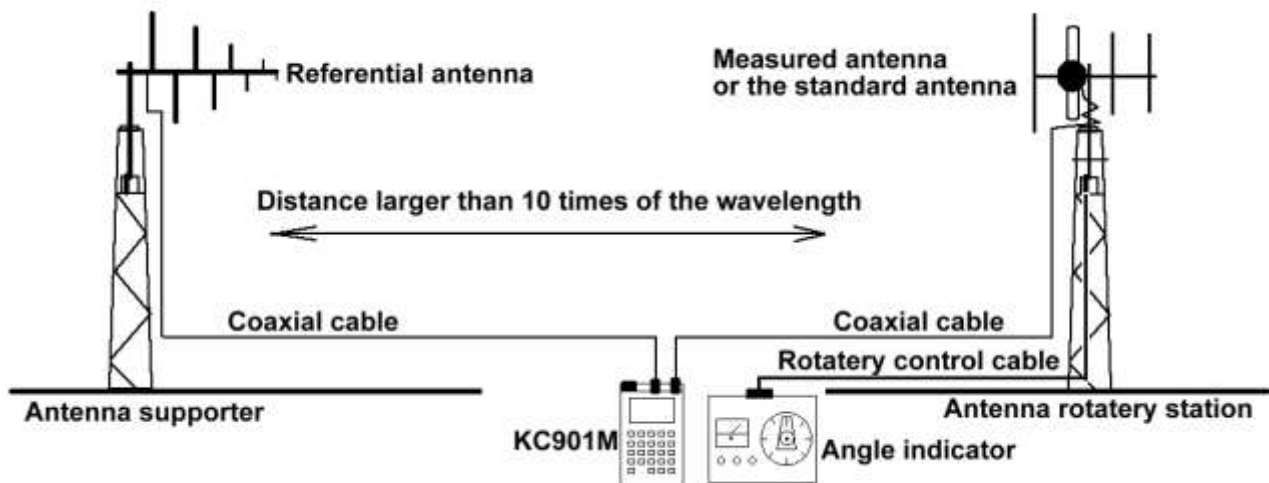

Chart 4-3: Measuring Antenna Gain in an Open Field

During the measurement, every measurement data can be saved by using the combined key **SHIFT+1** which is for further analysis. To be more user-friendly, KC901Q will name the files automatically and chronologically. Alternatively users can rename the file as saving with the combined key **SHIFT+3**.

Before measuring the testing antenna gain, install the reference antenna (with known gain) on the stand of the under-the-test antenna. Afterwards, adjust the orientations of the reference antenna and the testing antenna to aim (make the reference antenna aligns the under-the-test antenna according to the gain orientation which is already given). Then do the user calibration in S21 mode and keep the setting parameters of the instrument. Then replace the reference antenna with the under-the-test antenna, and test and record the S -parameters in every different angle. There derives the antenna gain in different angles by the summing up the tested parameter and the gain of the reference antenna.

Repeat the steps above if you need to test the directivity diagrams and gains in different frequencies.

Frequency can't be changed during the test, otherwise user calibration will be useless and the data will also be invalid. Meanwhile the operator should keep a far distance from the antenna especially when reading the meter .

When using two pc of KC901Q, they can make a scalar network testing system of single frequency point by setting one of KC901Qs in signal source and another one in FIELD mode. This system can be used when the two antennas are miles away from each other. One of the KC901Q, which is used for emission, can also be replaced by a transmitter that has a steady power level. Since the isolation in this way is better than the internal insulation of a single instrument, it can satisfy some testing applications which need a large dynamic range. Vice versa, if an operator needs a larger dynamic range to do other S21 tests, he/she can use a PC to control two pc of KC901Q at the same time).

4.3 Measuring Electric Length of Transmission Line

When the transmission line's end is in open circuit or short circuit, user can use KC901Q to measure its electric length. In mode S11, adjust it into PHASE display and take the part of the curve which is smooth and obviously periodical. Then measure the **frequency difference length ($\Delta\lambda$)** after the phase rolled one circumference (the difference between two cursors' frequencies is nearly 0°N) and divide it by 2 so as to obtain the electric length of the transmission line. After it, you can get the electric length of the transmission line. Of course, user can also measure the frequency difference length after the phase shifts 180°N . Then divide it with 4 to get the result directly, or try to get the result by measuring two frequency difference length after two 360°N .

User can also save the data first and then get the group delay by getting the derivation of the phase on PC to work out the electric length. In this case, user should choose the smaller SPAN or many sweeping points to avoid phase aliasing.

Take the SPAN which is as small as possible to make the curve in the display area go through one or two periods so that it can get the higher range resolution.

If connect the under-the-test transmission line through the patch cord, user needs to do the user calibration on the end of the patch cord. In this time, the cable length compensation needs to be set as zero in FUNC menu.

What chart4-5 shows is the typical curve when testing the electric length. This cable electric length is 1.432m. The actual length which is already known is 1.005m. The velocity coefficient can be calculated as 0.7018.

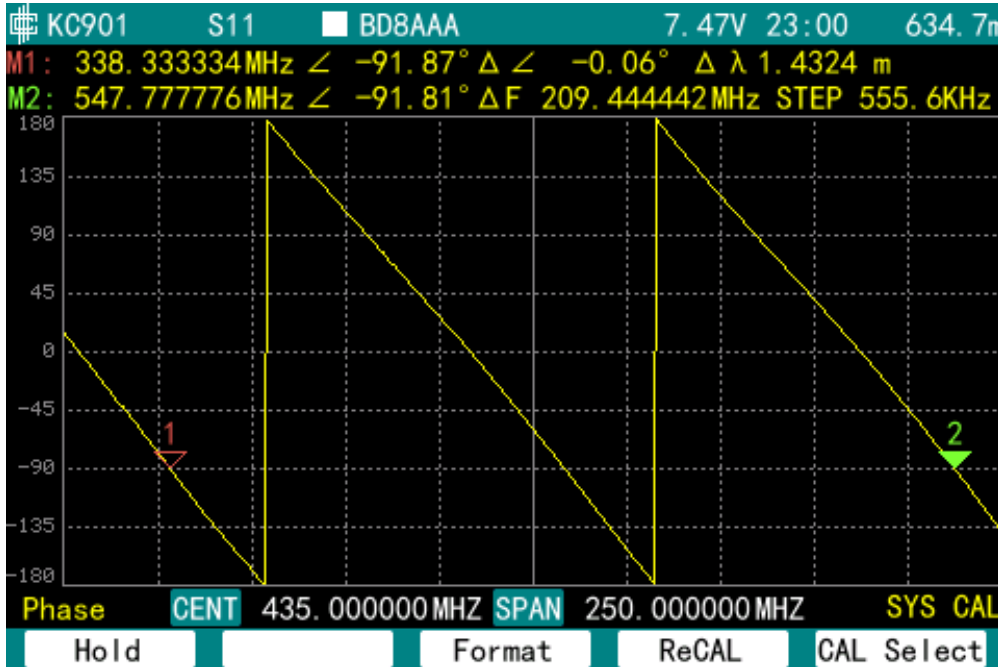

Chart 4-5: Measuring the Cable Electric Length in Phase Frequency Characteristic

When the cable's end is open circuit or short circuit, the cable loss is about half of the return loss. When there is an antenna in cable connection, the echo loss in antenna's non-working frequency can be used for evaluating the cable loss preliminarily.

4.4 Spectrum

We have enhanced the performance of KC901Q's input circuit. Therefore, it can provide simple spectrum analysis display.

Warning:

KC901Q's input port's maximal limit level is +20dBm. Limiting direct voltage is 15V. Once beyond them, the instrument will be broken immediately. When testing the transmitter or the amplifier, a series of attenuators concatenated could assure the input stays within the limitation at any time.

NOTice:

The determined maximum limiting power input level is for sake of keeping the instrument safe only. It doesn't guarantee the testing accuracy at this level. To obtain more precise results, the input level should less than +13 dBm.

KC901Q is an VNA, its spectrum function is only for review use.

KC901Q's spectrum mode can be interfered by the mirror image. So if it is used for monitoring, concatenating a narrow-band filter on the input port is suggested. When testing the short-wave frequency spectrum, concatenate a low-pass filter (e.g. KC9504.02), which the cut-off frequency is 30MHz with suppression over 80dB at 110MHz, and then use it to filter the mirror image interference and IF feed-through interference. User can also use different Local Mode to identify the mirror image response. If there is IF feed-through interference, concatenate the 110MHz trap filter (KC9504.03).The IF of KC901Q is 109.65MHz, if there is a interfere on 109.65MHz, it must be notch the interfere or KC901Q will not measured a available result.

There may occur a confusing peak of interference by another mirror which is approximately 40dB lower than the main peak. It can be told from switching between High LO and Low LO.

Better use the narrow-band antenna when the chosen frequency range is narrow. Set CENT and SPAN according to the frequency range which needs to be tested. Also set the AMP accordingly to the strength of the under-the-test signal. When searching the weak signal, AMP should be set ≤ -40 dBm. Adopt smaller SPAN for more meticulous sweep.

4.5 Detecting Interference Source

In the frequency band which has no image interference, user can detect the interference source with KC901Q by searching the maximum signal strength direction.

After entering the frequency spectrum, set CENT to the frequency which may be interfered and SPAN to a smaller value (1MHz for example). When the interference is feeble, set AMP as -60dBm. Search the interference signal by adjusting antenna's directivity and its polarization mode till there appears a maximum bump in the central of the spectrum. Use the magnetic compass to mark the azimuth angle of antenna's directivity and then draw a direction indication line on the map. Next, find another

place to do the test again and draws another direction indication line. The crossover point of these two lines is the most probable location of the potential interference source.

The line formed by the two testing points should cross with either one direction line (mentioned above) at an angle between 60-120 °N, better close to 60 °N. (Chart 4-4)

The monitoring location should better be high and capacious enough to avoid obstructive objects (such as buildings). Approaching the interference source, adjust AMP according to the signal strength or use the field strength mode. Move towards the strongest signal and gradually approach the interference source (the tested range should be over 70dBμ (-37dBm) near the interference source).

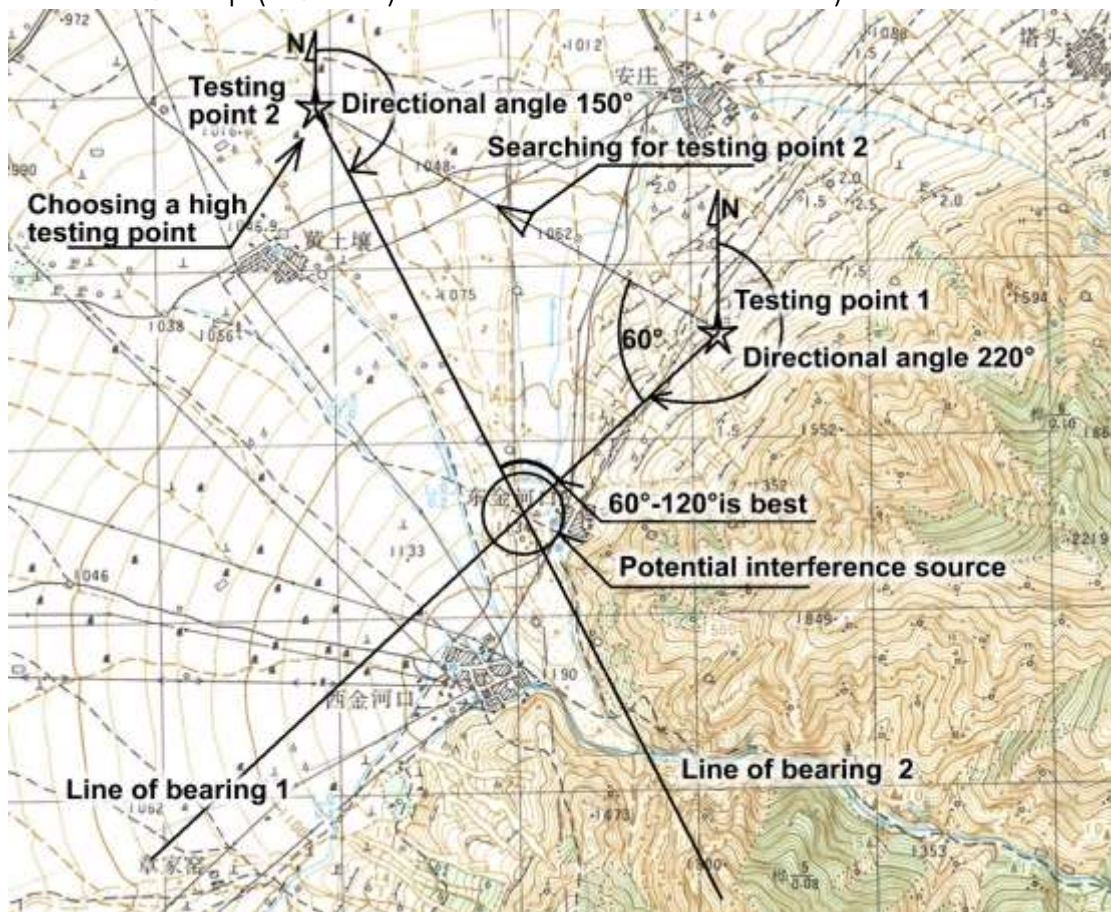

Chart 4-4: Crossover Point and Operation Example on Map

Putting band pass filters between antenna and instrument can greatly improve the testing reliability. Usually this filter is in helical structure or in cavity structure. Before using it, user can adjust its pass-band frequency under KC901Q's monitoring. When the testing signal is weak, user can also concatenate LNA (low noise amplifier) between the filter and the instrument.

To locate an interference source exactly, besides the guiding theories and auxiliary technologies, what you need are continuous practices to accumulate necessary experiences and skills so as to enhance efficiency and effectiveness. After several

tests, especially the tests in cities and mountain areas, there will be various illusory directions because of signal's diffraction and the reflection.

* For the narrow-band signal, the interference source will have higher response speed by being searched in field strength mode.

* When testing the emission field around radio station's antennas, field strength mode must be used. The medium frequency gain in the frequency spectrum mode should be set by users themselves, but keep in mind that it may be broken by the strong signal because of the wrong setting.

Warning:

Unless permitted, DO NOT monitor the space frequency spectrum of the non-working frequency with KC901Q. Even if you accidentally do so, don't reveal the data to anyone.

Chapter Five : Maintenance

5.1 How to Clean the Screen, Keyboard and Ports

The glass pane of the display screen is replaceable. remove the protective film from the screen, otherwise it will reduce the visibility under the sun.

Clean the display screen and the keyboard with a piece of wet tissue and dry up with a gauze.

If there is dust inside, take the control circuit board apart, and clean it by blowing it with 0.2MPa compressed air. If it's necessary, change a new display screen and the keyboard rubber.

Please clean the RF adaptors regularly. To start with, clean the inside of the ports with dry cotton swabs. Then clean it with a cotton swab dipped with a bit of alcohol. Core needle's end face and the inside/outside steps of connector's shell must be cleaned very well. Core needle's hole can be cleaned by spinning into it a slimly twisted tissue.

Warning:

Before taking apart of the circuit board, all batteries and the charger must be removed. Users can take apart of the instrument shell and the control circuit board to install the batteries and clean the display screen, after which warranty is still granted. But it will be out of the warranty range if there is any problem and damage caused during taking it apart.

Wiping the instrument on any part with organic solvent is forbidden. Also be careful not letting any fluid flow into the barometer.

5.2 Other Points for Attention

1. Please place the instrument into the suitcase or package during long-distance transportation. Once taking out, tie it up to a strap to safe it from falling and crashing. Do NOT put it together with something hard such as construction tools.

2. When testing some heavy devices, or connecting some thick and strong coax cables, users should employ flexible cables to do the switch-over. Additionally, users should perform calibration to erase the influence of the patch cord.

3. When installing the connector, insert it carefully into the right position. When the core needle fits exactly into the core hole, screw the thread tight. Use one hand to hold the instrument still and keep it from spinning, the other hand to rotate the barrel. Also pay attention and check the connectors not frequently used. If the core needle is too long or bent, repair it before connecting.

4. The instrument is NOT waterproof or moisture-proof. Thus as it gets wet, turn off the power immediately and shake out the water from its bottom. Also disassemble the instrument immediately and take out the batteries. Anyway if using the instrument outdoors, better prepare a waterproof case.

5. In freezing winter, be aware of the sharp temperature difference that may form dews in the inner part of the instrument. keep the instrument into a sealed plastic bag right before taking it indoors from outdoors until the instrument suffers no temperature difference. If there are dewdrops on the instrument, dry it before starting.

6. In order to protect the batteries, charge the batteries regularly and not wait till the power-shortage warning alerts. Also long-term floating charge is not permitted. Take out the batteries before long-time charging.

7. Before setting aside the instrument for long time, make sure it remains 0.8V voltage, and better remove the batteries. Also charge it at least once a year to 8.0V despite it is idle.

8. Keep the instrument away from the high-power emission source, including the ordinary walkie-talkie.

9. Ionization radiation may bring damages to the instrument; so will the neutron exposure that could cause the irreversible damages to the instrument.

10. The USB plug is fragile. So use the flexible data cable and try to avoid the lateral force.

11. Instrument's retesting period is 1 year. It is advised to send it back to the manufacturing factory to do the retest or calibration.

12. The warranty period is 1 year. Warranty does not include damages caused by normal wear of the ports or the appearance, and any the artificial damage.

13. DO NOT take apart of instrument's shell casually in that this is a precise instrument, any damages caused by careless operation are beyond the warranty. Pay attention that the instrument will not be eligible for warranty once the RF module being disassembled.

Chapter Six Technical Specification

6.1 Measurement Theory

KC901Q's circuit is comprised of one signal source and two receivers. The signal source is divided into three frequency bands: the signal lower than 60MHz is produced by DDS directly; 60MHz to 7GHz range is produced by PLL and through the attenuator. Upper the 7GHz signal was produced by multiplier and bypass the attenuator. The signal sources of three frequency bands are gated by a RF switch and converged into one RF signal to output.

Both receivers are digital-IF synchronous receivers. S21 function is so-called "simplified vector" in that in this mode, the instrument's receivers can only detect the forward signal but not the reverse signal. So it can only run the simplified calibration model. It only erases the errors of the frequency response.

Check Chart 6-1 for KC901Q's schematic diagram.

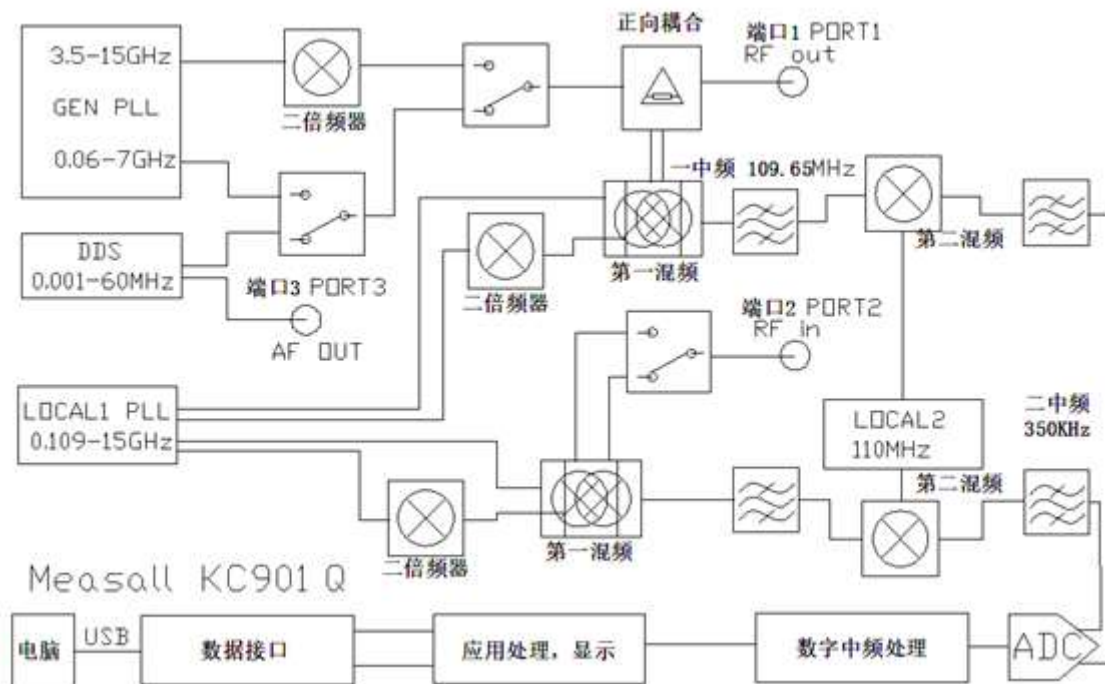

Chart 6-1: KC901Q's Schematic Diagram

KC901Q's signal source generates a RF CW signal and output at port 1 when measuring S11 parameter. Use the Forward divider to get the forward signal and then use a external Directional Coupler to get the reverse signal. The forward signal and the reverse signal are sent to two receivers respectively. After double -conversion and ADC sampling, these two signal become a digital string and then are sent to a FPGA for further processing to measurement the phase and the amplitude.

When measuring S21 parameter the signal source will output to port 1, after going through the DUT the signal input at port 2. After double -conversion, the transition measurement is based on the forward signal and the transition signal.

In audio source signal function, DDS is used for outputting the audio signal directly. KC901Q uses the digital synthesizer which the clock frequency is 400MHz. Therefore the audio signal source function can produce signal which the frequency is over 50MHz. Also it supports FM, but the performance is not guaranteed.

6.2 Charging Time and Endurance Time

The Rated charge current of KC901Q's batteries pack is 1A. The charging time depends on the batteries capacity. Currently the existing battery with maximum capacity in the market, has a single battery's capacity that can reach 3.4Ah. If installing four batteries, the charging time will be $4/2 \times 3.4 \approx 7h$. When a single battery has been charged to 4.2V and the voltage of battery pack is 8.4V, the instrument will stop the charging automatically. When the temperature is too low or too high, instrument will also slow down the charging speed.

KC901Q's endurance time is decided by the battery's capacity and its applying function. Turning on mode S11 and mode S21 simultaneously, together with one or more than one receivers, consumes more power than using any other functions.

Functions like frequency spectrum, field strength, signal source are most power-saving, since they only need to start up signal source and one of the receivers. When in STOP state, the whole RF circuit will be turned off. In this time, only the processor and other display part are consuming the power.

When installing four batteries, the display screen's luminance is 20%. At the same time, when the temperature is 15 °C, the endurance time of different functions are shown in following table (Table 1). This table is only for reference. The endurance time will be less when the temperature is too high/low or the battery's actual capacity is lower than stipulated.

Table 1	Endurance Time			
Function/Capacity	2200mAh	2600mAh	3100mAh	3400mAh
RF (S11)	1.5	2.5	3	4
Transmission/Insertion Loss	1.5	2.5	3	4
Spectrum/Field Strength	2	3	4	5
RF Signal Source	2	3	4	5
Audio Signal Source	6	8	10	12
Stop/Pause	12	15	19	21

If there are only two batteries installed, the discharge rate becomes higher, so the endurance time will be half less than the time above.

6.3 Technical Parameter

Object	Test tate	Parameter			Note
		Min	Type	Max	
Freq. Range	Effective	9KHz		20GHz	
	SPEC can setting	0		30GHz	
Sweep Range	SPAN	1KHz		29.99GHz	
Sweep point		450pt		3150pt	Local
Freq. Resolution	All Sweep Function		1Hz		
	Single Point Function		0.1Hz		
Level Resolution			0.01dB		
Phase Resolution			0.01°		
Sweep Speed	RBW=30KHz, each point		1.2ms		
	RBW=10KHz, each point		1.5ms		
	RBW=3KHz, each point		2ms		
	RBW=1KHz, each point		4ms		
	RBW=30K, 450pt each frame		0.6s		
Output level (sweep)	1MHz-7.5GHz	-10dBm	6dBm	10dBm	
	7GHz-20GHz	-13dBm	0dBm	6dBm	

Output level	1MHz-7GHz Generator	3dBm	10dBm	13dBm	
	7GHz-20GHz Generator	-13dBm	0dBm	6dBm	
Output attenuator	9kHz-7GHz	0dB		25dB	See note 2
Sensitive	1MHz-7GHz	-101dBm	-107dBm	-113dBm	Port2 RBW=1KHz
	7GHz-15GHz	-98dBm	-104dBm	-110dBm	
	15GHz-22GHz		-95dBm	-101dBm	
Transmission measurement dynamic range	1MHz-1GHz	95dB	100dB		Equivalent to isolation range See note 3
	1GHz-2GHz	85dB	90dB		
	2GHz-15GHz		70dB		
	15GHz-24GHz		60dB		
24GHz-26.5GHz		40dB			
Transmission measurement uncertainty	After through calibration and L<60dB		0.5+0.1L		See note 4
Insertion loss zero drift	L<30dB 1MHz-15GHz		0.1dB		Warn-up 5min
Coupler directional after calibration	9kHz-7GHz		45dB		External coupler needed, directional>15dB
	7GHz-15GHz		40dB		
	15GHz-20GHz		35dB		
	20GHz-26GHz		25dB		
Return Loss Uncertain	After through calibration, 3dB < RL < 25dB 时		1.5+0.1RL		External coupler needed

Phase Uncertain	9kHz-10MHz		5°		Loss @20dB
	10MHz-7GHz		3°		
	7GHz-15GHz		8°		
	15GHz-20GHz		15°		
Spectrum Uncertain	1MHz-7GHz		1.5dB		CW signal
	7GHz-26.5GHz		3dB		
Port VSWR	Port 1 1MHz-7GHz		1.5		Dynamic
	Port 1 7GHz-20GHz		2.0		
	Port 2, 1MHz-7GHz		1.5		
	Port 2, 7GHz-20GHz		2.0		
Lo leakage	<6GHz		-40dBm	-20dBm	
	≥6GHz		-30dBm	-20dBm	
IF Feedthrough	<6GHz		10dB		
	≥6GHz		30dB		
First IF image attenuation			0dB		
Second IF image attenuation			40dB		
Frequency stability, year			0.3ppm	1ppm	
Power Voltage, DC port		11V		32V	

Temperature	Power adapter	105V		230V	See Note 5
	battery	6.5V		8.4V	
	Operation	0°C		45°C	
Humidity	Allow	-40°C		65°C	
				95%	
Broken Level	RF Port DC15V,			+20dBm	
Demension	200×114×46mm (L×W×T)				
Quality (Battery in- cluded)	Package		2.0kg		
	Instrument		1.2kg		

Note1: Expect there are other specifications, the indexes are all tested through user calibration in these following conditions: slow mode, RBW is 1KHZ,output attenuation is 0,temperature is 25 °C. Some minority and accidental parameters, or some permanent parameters may be out of the technical parameter range.

Note 2: The audio source can provide 60dB digital attenuate.

Note 3: Using dummy load connected to port, preparation about 20dB less in use.

Note 4: Using a 10dB attenuator connect to Port 1 to improve the port unmatched error.

Note 5: When using battery power the temperature range is depend on the batter's temperature performance. When using the instrument out of 0° C to 45° C, need to wait the instrument warming up and calibration again. Especially in -40° C to -20° C range, the instrument need continuity run at least 5mins. The instrument shield will high than environment temperature about 20° C , When use the instrument in high than 45° C environment need to avoid the scald. When the environment up to 65° C must remove the battery of instrument or it will cause danger.

6.4 Inside Ports

The back side of RF module inside the instrument have 4 unconnected ports.

J6: EXT Clock input,the Clock frequence is 20MHz

J7: Clock Output, frequence is 20MHz

J8: Trigger Input

J9: Trigger Output

[END]